

# VANTAGE VAR

18865 GOLL ST. - SAN ANTONIO, TX. - 78266 - ph.210-654-7171 - fax 210-654-3113

## **SLIMLINE**

HEAT /COOL/DEFROST

11300-VUZ-A  
11400-VUZ-A

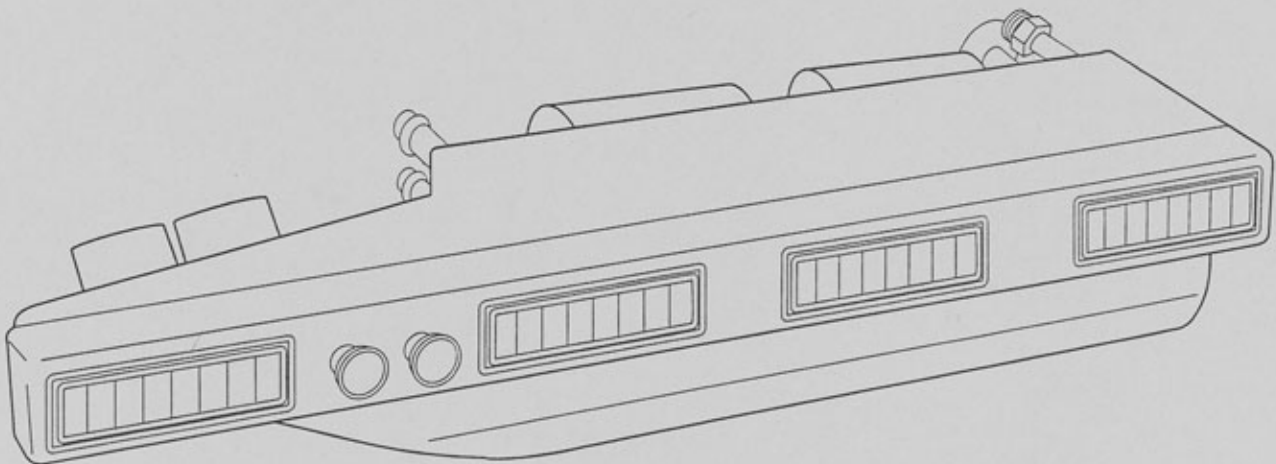

## **Table of Contents**

### PAGES

1. COVER
2. TABLE OF CONTENTS
3. PACKING LIST
4. INFORMATION PAGE
5. INSTALLATION
6. INSTALLATION CONTINUED
7. HOSE ROUTING
8. O-RING/FITTING INSTRUCTIONS
9. HEATER HOSE INSTALLATION
10. WIRING DIAGRAM
11. THERMOSTAT ADJUSTMENT
12. EVAPORATOR KIT PACKING LIST

**EVAPORATOR KIT  
11300-VUZ-A  
11400-VUZ-A**
**EVAPORATOR KIT PACKING LIST**

No.	QTY.	PART No.	DESCRIPTION
1.	1	55323-VUE-A	EVAPORATOR SUBCASE H/C/D w/ STD LOUVERS
		55423-VUE-A	EVAPORATOR SUBCASE H/C/D w/ BLK LOUVERS
2.	1	64143-VUE	FRONT EVAPORATOR BRKT. KIT
3.	1	63380-VUE	COMPAC DEFROST DUCTS
4.	1	63300-VUE	IK KIT
5.	6	06200-VUE	2" DEFROST DUCTS

**\*\* BEFORE BEGINNING INSTALLATION OPEN ALL PACKAGES AND CHECK CONTENTS OF SHIPMENT. PLEASE REPORT ANY SHORTAGES DIRECTLY TO VINTAGE AIR WITHIN 15 DAYS. AFTER 15 DAYS, VINTAGE AIR WILL NOT BE RESPONSIBLE FOR MISSING OR DAMAGED ITEMS.**

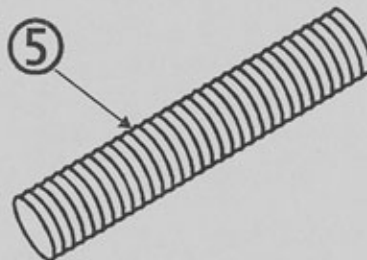
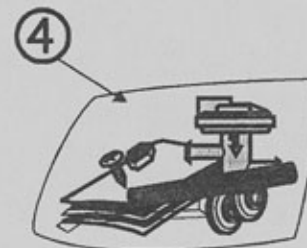
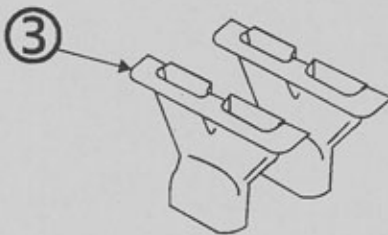
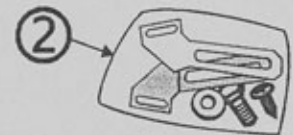
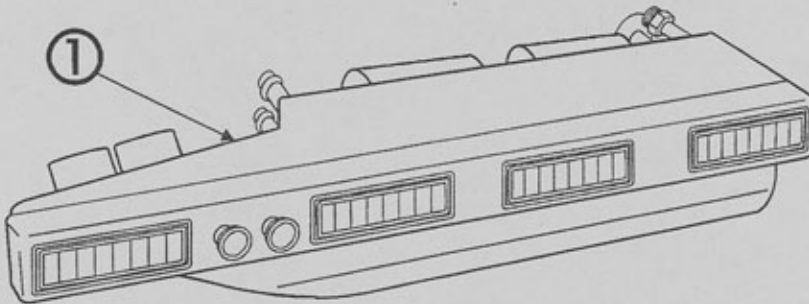

# SLIMLINE

## HEAT/COOL/DEFROST

### IMPORTANT NOTICE-PLEASE READ

**FOR MAXIMUM SYSTEM PERFORMANCE  
VINTAGE AIR RECOMMENDS THE FOLLOWING:**

#### **SAFETY SWITCHES:**

VINTAGE AIR ALWAYS RECOMMENDS AN OPTIONAL COMPRESSOR SAFETY SWITCH BE INSTALLED ON EVERY A/C SYSTEM. A BINARY SWITCH (PART # 24679-VUS) DISENGAGES THE COMPRESSOR CLUTCH IN CASE OF EXTREME LOW PRESSURE CONDITION (REFRIGERANT LOSS) OR EXCESSIVELY HIGH HEAD PRESSURE (406 PSI.), TO PREVENT COMPRESSOR DAMAGE OR HOSE RUPTURE. A TRINARY SWITCH (PART# 24678-VUS) COMBINES HI/LO PRESSURE PROTECTION WITH AN ELECTRIC FAN OPERATION SIGNAL AT (254 PSI.) COMPRESSOR SAFETY SWITCHES ARE EXTREMELY IMPORTANT SINCE AN A/C SYSTEM RELIES ON REFRIGERANT TO CARRY LUBRICATION THROUGH THE SYSTEM.

#### **SERVICE INFO:**

EVACUATE THE SYSTEM FOR 35-45 MINUTES WITH SYSTEM COMPONENTS (DRIER, COMPRESSOR, EVAPORATOR AND CONDENSER) AT A TEMPERATURE OF AT LEAST 85° F. ON A COOL DAY THE COMPONENTS CAN BE HEATED WITH A HEAT GUN OR BY RUNNING THE ENGINE WITH THE HEATER ON BEFORE EVACUATING.

LEAK CHECK AND CHARGE TO SPECIFICATIONS.

**THE PROPER AMOUNT OF REFRIGERANT IS CRITICAL TO PROPER SYSTEM OPERATION. VINTAGE AIR RECOMMENDS OUR SYSTEMS BE CHARGED BY WEIGHT WITH A QUALITY CHARGING STATION OR SCALE.**

#### **REFRIGERANT CAPACITIES**

##### **134a SYSTEM**

CHARGE WITH 1.8 LBS. OF REFRIGERANT

##### **R-12 SYSTEM**

CHARGE WITH 2.0 LBS. OF REFRIGERANT

#### **LUBRICANT CAPACITIES**

NEW COMPRESSOR - NO ADDITIONAL OIL NEEDED  
USED COMPRESSOR - CONSULT VINTAGE AIR

## INSTALLATION

- ❑ ATTACH EVAPORATOR BRACKETS TO EVAPORATOR (SEE FIGURE 1).
- ❑ POSITION EVAPORATOR WITH BRACKETS UNDER DASH. MARK AND DRILL TWO (2) 9/32" DIAMETER HOLES UNDER THE LIP OF THE DASH.
- ❑ ATTACH THE FRONT BRACKETS TO DASH WITH 1/4" x 1" BOLTS, WASHERS AND NUTS PROVIDED (SEE FIGURE 1).
- ❑ ATTACH REAR EVAPORATOR BRACKETS (USING TWO #8 x 1/2" SHEET METAL SCREWS) TO THE COWL OR FIREWALL.
- ❑ ATTACH THE DRAIN HOSE (SEE FIGURE 2) AND DRILL A 9/16" DIAMETER HOLE IN FIREWALL 1" BELOW THE BOTTOM OF THE EVAPORATOR.

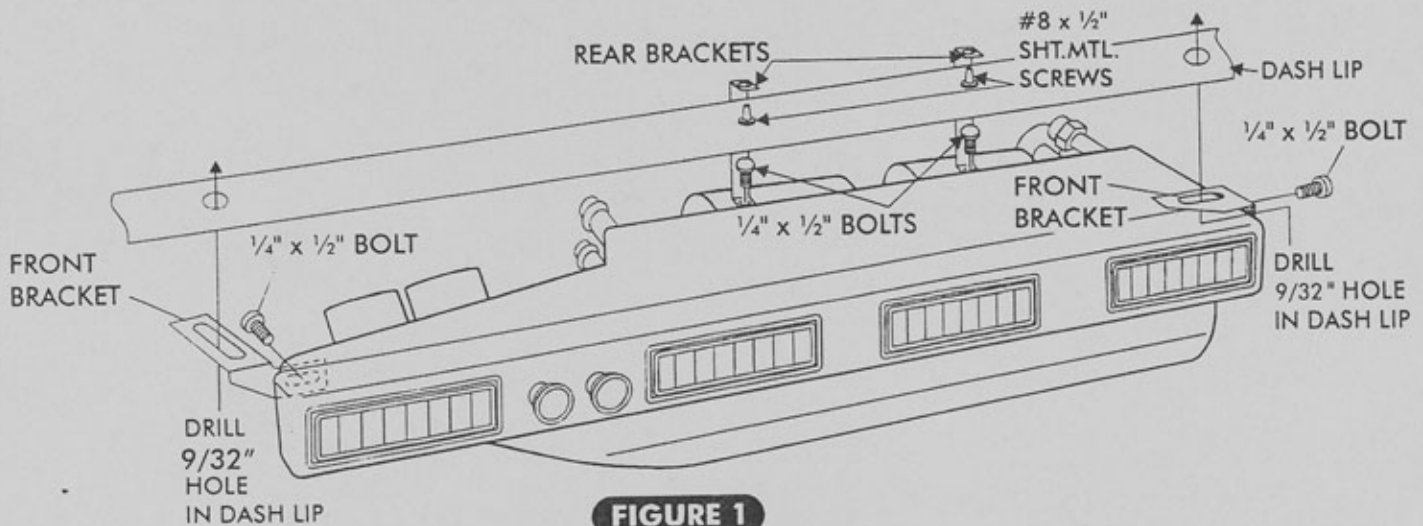

**FIGURE 1**

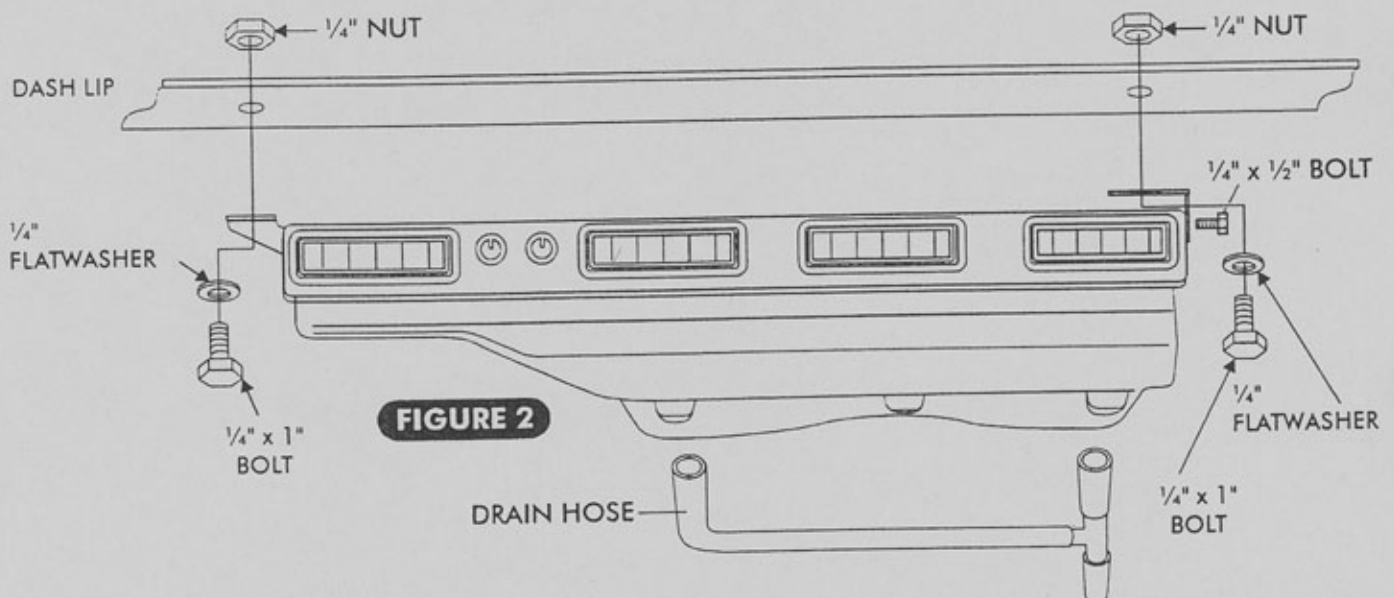

**FIGURE 2**



- PUSH THE 5/16" I.D. HOSE ONTO THE STRAIGHT #6 FITTING. (SEE HOSE ROUTING ILLUSTRATION ON PG. 7). INSTALL THE FITTING ONTO THE EXPANSION VALVE (FINGER TIGHT). PUSH THE 1/2" I.D. HOSE ONTO THE STRAIGHT #10 FITTING, AND INSTALL THE FITTING ONTO THE #10 LINE ON THE EVAPORATOR. (SEE HOSE ROUTING ILLUSTRATION PG. 7).
  - AT THIS TIME, TRY TO DETERMINE WHERE YOU WANT YOUR LINES TO GO THRU THE FIREWALL. MOVE THE HOSES TO THAT POINT. HOLD THE FITTINGS UP TO THEIR RESPECTIVE HOSES, AND DETERMINE IF THE HOSES WILL CONFORM TO THE LOCATION FOR THE BULKHEAD FITTINGS OR OPTIONAL BULKHEAD PLATE (VINTAGE AIR PART #34215-VUQ OR 34217-VUQ). THE 1/2" HOSE IS HARD TO BEND AT A SHARP ANGLE, AND THE FITTINGS TAKE UP A CERTAIN AMOUNT OF SPACE. BEFORE YOU DRILL HOLES IN YOUR FIREWALL, MAKE SURE THAT YOU CAN MAKE THE HOSES FIT WHERE YOU HAVE PLANNED. THE ENGINE COMPARTMENT APPEARANCE IS A CONSIDERATION WHEN CHOOSING THIS LOCATION.
  - WHEN YOU HAVE DECIDED WHERE YOU WANT TO PLACE YOUR BULKHEAD FITTINGS, MARK THESE POINTS WITH A GREASE PENCIL, AND MAKE A TEMPLATE FROM THE INSIDE LOCATING WHERE THE HOLES WILL BE CUT. WITH THIS TEMPLATE, LOCATE THE SAME POINTS ON THE OUTSIDE OF THE FIREWALL. MARK THESE POINTS WITH A GREASE PENCIL.
  - DETERMINE THE BEST LOCATION FOR THE DRIER THAT WILL ALLOW ADEQUATE ROOM FOR THE HOSE AND FITTINGS THAT CONNECT THE DRIER TO THE BULKHEAD FITTING.
  - MOUNT THE DRIER. (KEEP THE DRIER CAPPED AS MUCH AS POSSIBLE, IF YOU MUST SCREW THE FITTING TO THE DRIER, TAPE IT CLOSED).
- NOTE: THE DRIER IS USUALLY MOUNTED WHERE YOU HAVE ROOM FOR IT. JUST REMEMBER TO MOUNT IT IN THE COOLEST SPOT POSSIBLE AND VERTICALLY SO THE SIGHT GLASS IS DIRECTLY ON TOP. (NOT NEXT TO THE EXHAUST MANIFOLD). IT CAN BE MOUNTED INSIDE THE VEHICLE AS WELL.**
- AT THIS POINT, CUT HOLES FOR BULKHEAD FITTINGS, AND INSTALL THEM.
  - USING THE HOSE ROUTING ILLUSTRATION AS A GUIDE, ROUTE REMAINING A/C LINES, AND CUT TO LENGTH.
  - AT THIS TIME, YOU SHOULD HAVE THE REFRIGERATION HOSES CUT TO THEIR PROPER LENGTH. **PAY CLOSE ATTENTION TO THE ORIENTATION OF ANY HOSE WITH TWO ANGLED FITTINGS.** ANY HOSE WITH TWO ANGLED FITTINGS MUST BE MARKED FROM THE HOSE TO THE FITTINGS TO ASSURE THEY WILL REMAIN IN THIS POSITION AFTER CRIMPING. THE RUBBER HOSE IS ONLY CAPABLE OF A MINIMAL AMOUNT OF TWIST TO AID ALIGNMENT.
  - REMOVE HOSES AND CRIMP ENDS. IF YOU DO NOT HAVE ACCESS TO THE PROPER EQUIPMENT, YOU MUST TAKE THEM TO A QUALIFIED A/C SERVICE CENTER FOR CRIMPING. (SEE CRIMPING INSTRUCTIONS SUPPLIED WITH THE HOSE KIT).
  - WITH THE EVAPORATOR TRIAL FIT COMPLETE, YOU MAY REMOVE UNIT AND LOWER IN VEHICLE.
  - AFTER CRIMPING HOSES, LOCATE THE #6 A/C HOSE WITH THE STRAIGHT FITTING. LUBRICATE A #6 A/C O'RING AND THE THREADS ON THE FITTING, AND INSTALL ON THE EXPANSION VALVE. TIGHTEN CAREFULLY. REFER TO FIGURES 3 & 3A, PAGE 8.
  - LOCATE THE #10 A/C HOSE WITH THE STRAIGHT FITTING. LUBRICATE A #10 O'RING AND THE THREADS ON THE FITTING, AND INSTALL ON THE #10 LINE OF THE EVAPORATOR. TIGHTEN CAREFULLY. REFER TO FIGURES 3 & 3A, PAGE 8.
  - WRAP THE #10 FITTING WITH PRESS TAPE, AND COVER ALL EXPOSED METAL SURFACES. (DO NOT WRAP THE #6 HOSE, FITTING, OR THE HEATER CORE TUBES). SEE FIGURE 3, PAGE 8.

**(31700-VBD)**

WHITE HOSE INDICATES LOW-PRESSURE

BLACK HOSE INDICATES HIGH-PRESSURE

90° & STRAIGHT EVAPORATOR FITTINGS INCLUDED IN VINTAGE AIR HOSE KITS.

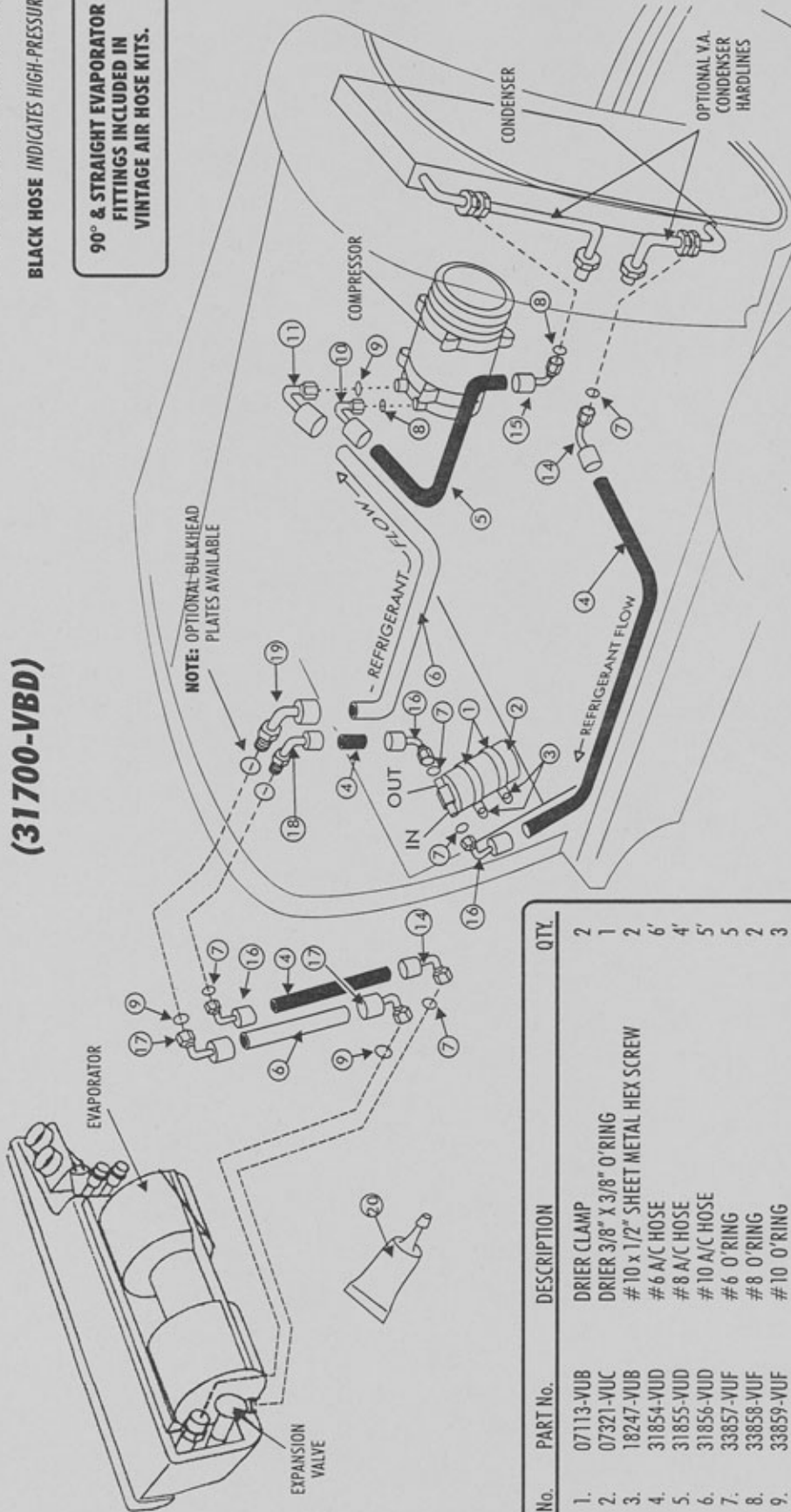

**IMPORTANT NOTICE  
PLEASE READ**

THIS HOSE KIT CONTAINS CRIMP FERRULE FITTINGS. FITTINGS MUST BE CRIMPED WITH THE APPROPRIATE 134A CRIMPING TOOL. IF YOUR HOSE KIT IS NOT A 31700-VBD REFER TO THE INSTRUCTIONS INCLUDED WITH YOUR PARTICULAR HOSE KIT FOR CRIMPING.

No.	PART No.	DESCRIPTION	QTY.
1.	07113-VUB	DRIER CLAMP	2
2.	07321-VUC	DRIER 3/8" X 3/8" O'RING	1
3.	18247-VUB	# 10 x 1/2" SHEET METAL HEX SCREW	2
4.	31854-VUD	# 6 A/C HOSE	6'
5.	31855-VUD	# 8 A/C HOSE	4'
6.	31856-VUD	# 10 A/C HOSE	5'
7.	33857-VUF	# 6 O'RING	5
8.	33858-VUF	# 8 O'RING	2
9.	33859-VUF	# 10 O'RING	3
10.	35542-VUG	# 8 BL-FTG 135° FM-O'RING w/134 PORT	1
11.	35543-VUG	# 10 BL-FTG 135° FM-O'RING w/134 PORT	1
12.	35811-VUG	# 6 STRAIGHT BEADLOCK O'RING FTG	1
13.	35813-VUG	# 10 STRAIGHT BEADLOCK O'RING FTG	1
14.	35821-VUG	# 6 BEADLOCK 45° FM-O'RING FTG	2
15.	35822-VUG	# 8 BEADLOCK 45° FM-O'RING FTG	1
16.	35831-VUG	# 6 BEADLOCK 90° FM-O'RING FTG	3
17.	35833-VUG	# 10 BEADLOCK 90° FM-O'RING FTG	2
18.	35881-VUG	# 6 BEADLOCK BULKHEAD 90° M-O'RING FTG	1
19.	35883-VUG	# 10 BEADLOCK BULKHEAD 90° M-O'RING FTG	1
20.	41117-VUP	REFRIGERANT OIL TUBE	1

## INSTALLATION

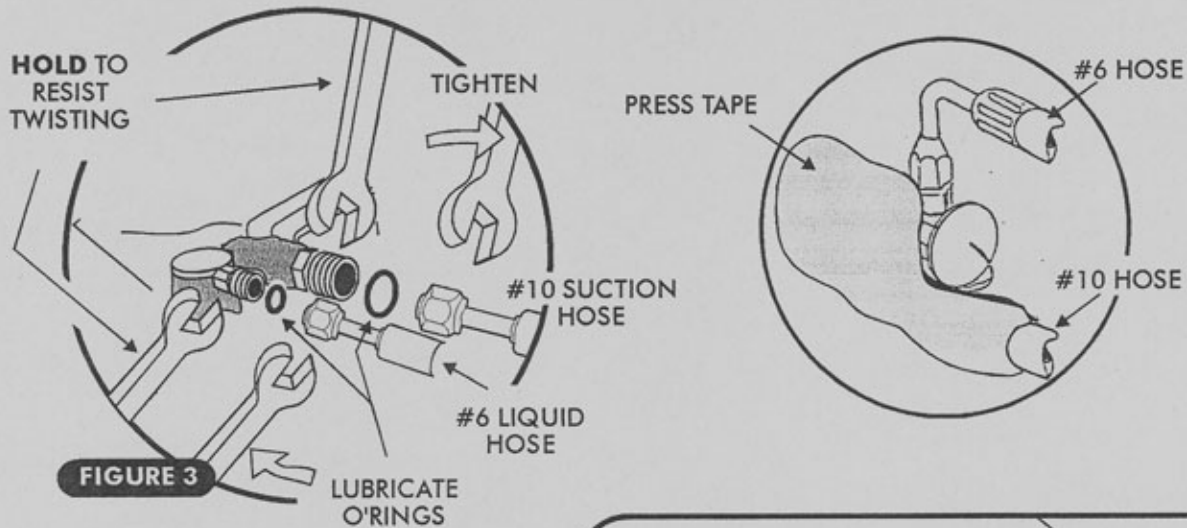

**FIGURE 3**

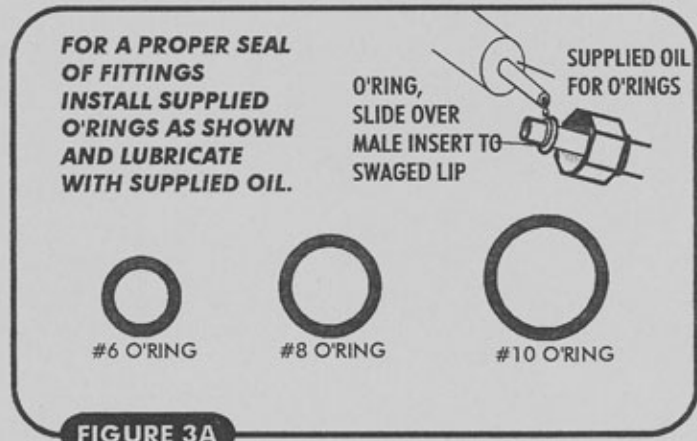

**FIGURE 3A**

- ROUTE HEATER HOSES (REFER TO HEATER HOSE ROUTING INSTRUCTIONS, PG. 9).
- MAKE ELECTRICAL AND/OR VACUUM CONNECTIONS, ACCORDING TO THE DIAGRAM FURNISHED ON PG. 10.
- NOTE: THE RED 12GA. WIRE WITH THE 30 AMP CIRCUIT BREAKER SHOULD BE CONNECTED TO A 12 VOLT POWER SOURCE OF AT LEAST 12GA. WIRE. CONNECT MOLDED PLUG WITH THE (RED, YELLOW, ORANGE) WIRES TO THE CORRESPONDING PLUG FROM THE BLOWER MOTOR. THE SINGLE BLACK WIRE FROM THE BLOWER MOTOR MUST BE GROUNDED. THE BLUE CLUTCH WIRE RUNS FROM THE THERMOSTAT TO THE COMPRESSOR SAFETY SWITCH AND FROM THE SAFETY SWITCH TO THE COMPRESSOR.

**BE CAREFUL TO ENSURE THAT THIS WIRE IS NOT PINCHED OR IN A POSITION TO RUB ON A SHARP EDGE AS IT GOES THRU THE FIREWALL. AN OPTIONAL VACUUM RESERVOIR WITH CHECK VALVE WILL HELP SYSTEM WORK UNDER A VARIETY OF CONDITIONS. (VINTAGE AIR PART #31200-VUS VACUUM RESERVOIR).**



## HEATER HOSE INSTALLATION

- AFTER THE EVAPORATOR IS IN PLACE, RUN 5/8" HEATER HOSE FROM THE BOTTOM HEATER FITTING ON THE EVAPORATOR THRU THE FIREWALL OR BEHIND THE KICK PANEL THRU FLOOR TO THE INTAKE MANIFOLD HEATER CONNECTION. INSTALL THE VACUUM HEATER CONTROL VALVE IN THIS LINE. (PRESSURE) SEE FIGURE BELOW. **(BE SURE TO FOLLOW FLOW ARROW ON HEATER CONTROL VALVE)**
- INSTALL 5/8" HEATER HOSE ON TOP FITTING OF HEATER. ROUTE HOSE THRU FIREWALL OR BEHIND KICK PANEL THRU FLOORBOARD AND OUT TO WATER PUMP CONNECTION. (SUCTION)

**FILL RADIATOR WITH AT LEAST A 50/50 MIXTURE OF APPROVED ANTIFREEZE AND WATER. IT IS THE OWNER'S RESPONSIBILITY TO KEEP THE FREEZE PROTECTION AT THE PROPER LEVEL FOR THE CLIMATE IN WHICH THE VEHICLE IS OPERATING. FAILURE TO FOLLOW ANTIFREEZE RECOMMENDATIONS WILL CAUSE HEATER CORE TO CORRODE PREMATURELY AND POSSIBLY BURST IN THE A/C MODE AND/OR FREEZING WEATHER, VOIDING YOUR WARRANTY. CHECK COMPLETE A/C ASSEMBLY FOR PROPER OPERATION. VINTAGE AIR RECOMMENDS THAT ALL A/C SYSTEMS BE SERVICED BY A CERTIFIED AUTOMOTIVE AIR CONDITIONING TECHNICIAN ONLY. SEE INSIDE COVER FOR SERVICE INFORMATION.**

- START ENGINE AND RUN, UNTIL NORMAL OPERATING TEMPERATURE IS REACHED. PLACE SWITCH IN HEAT POSITION, AND SELECT FAN SPEED DESIRED. THE SYSTEM WILL HEAT THE VEHICLE. **(BE SURE THE ENGINE THERMOSTAT HAS OPENED, AND THE APPROVED ANTIFREEZE MIXTURE HAS BEEN CIRCULATED THRU THE HEATER CORE BEFORE TESTING THE A/C MODES).**
- WHEN VALVE IS CLOSED, INLET SIDE OF VALVE SHOULD BE HOT AND OUTLET SIDE SHOULD BE COOL. WHEN THE VALVE IS OPEN, BOTH INLET AND OUTLET SIDES SHOULD BE HOT.

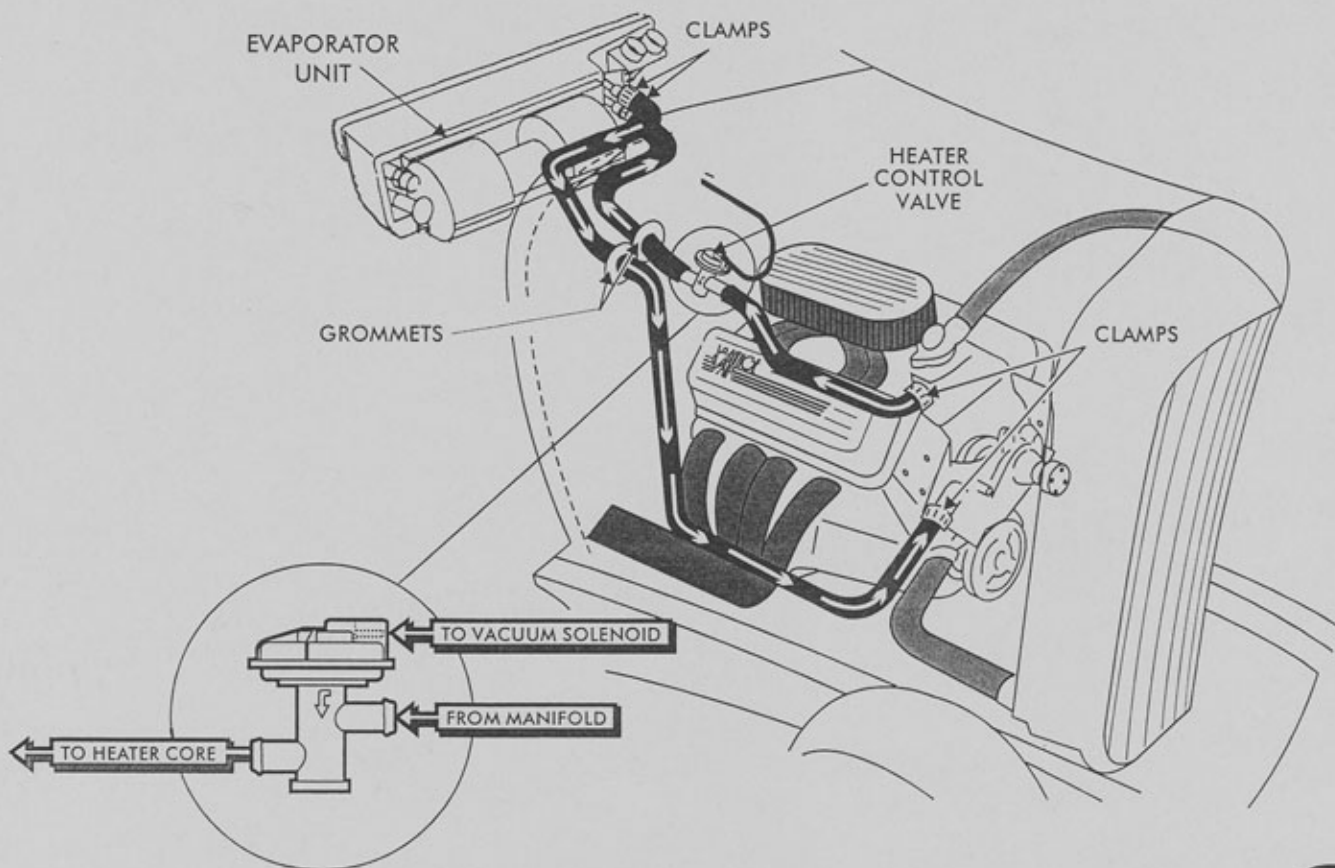

**WIRING/VACUUM DIAGRAM**  
HEAT/COOL/DEFROST

(OPTIONAL)  
COMPRESSOR  
SAFETY SWITCH  
(BINARY TYPE)

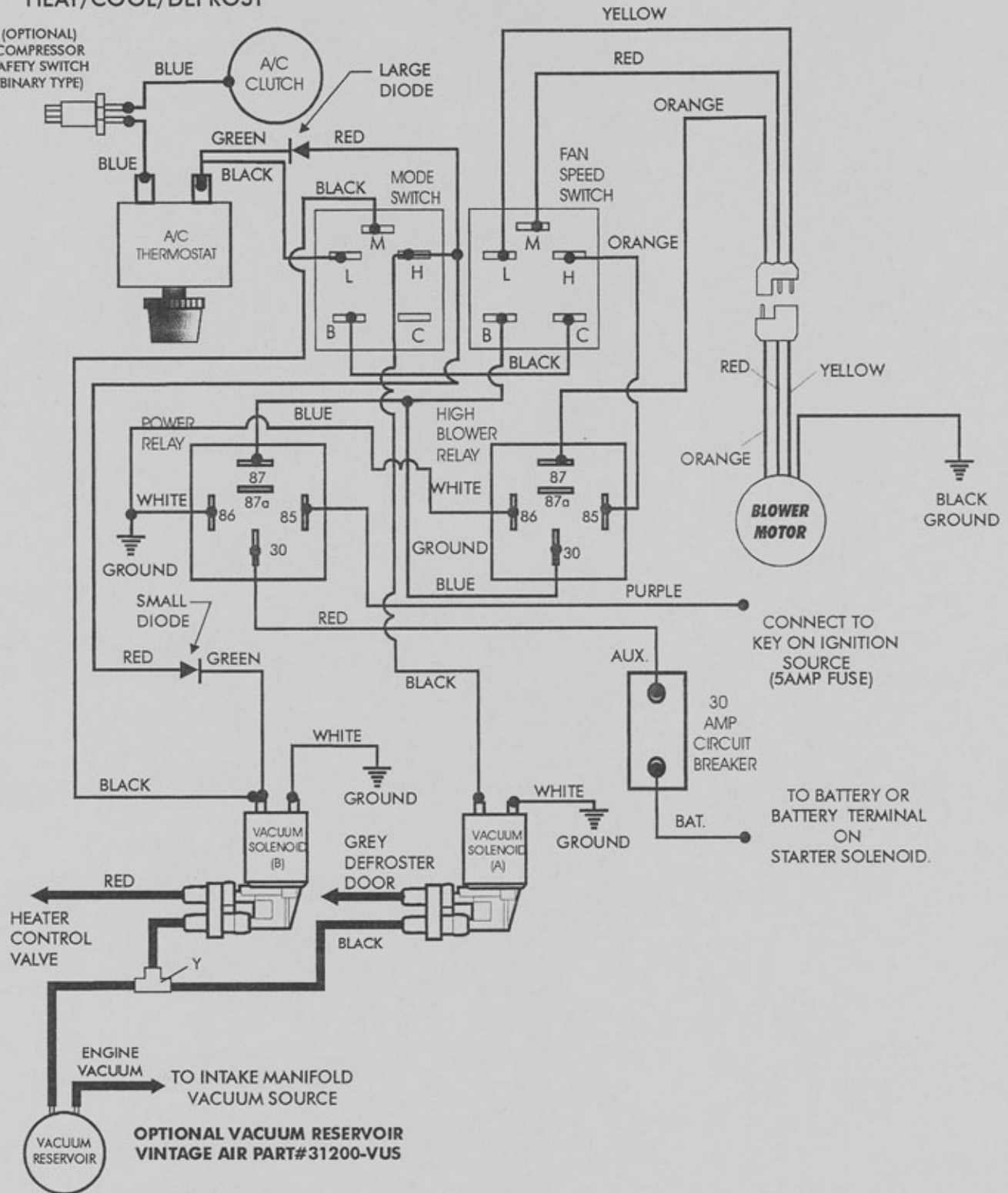

WIRES = ● ——— ●

VACUUM LINES = RED BLACK GREY

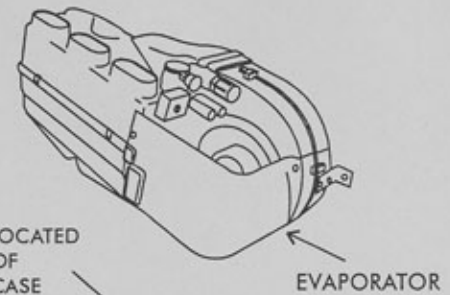
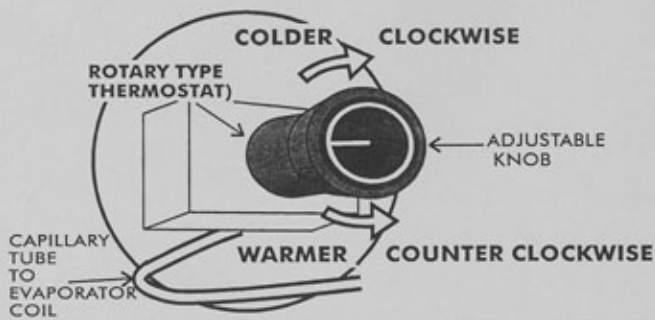

THIS STICKER LOCATED ON TOP SIDE OF EVAPORATOR CASE

EVAPORATOR

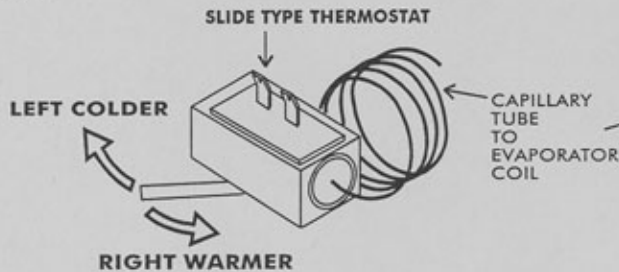
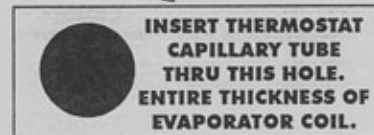

## AIR CONDITIONING ADJUSTMENTS:

- THE AIR CONDITIONER THERMOSTAT CONTROLS COIL TEMPERATURE. ROTARY TYPE THERMOSTATS ARE SHIPPED ADJUSTED FULLY COLD (CLOCKWISE), IN THE MAJORITY OF CASES THE A/C WILL OPERATE CORRECTLY AS SHIPPED.
- TURNING THE KNOB ON THE **ROTARY TYPE THERMOSTAT** TO THE RIGHT (CLOCKWISE) MAKES THE SYSTEM OPERATE COLDER. MOVING THE LEVER TOWARD COLDER ON THE **SLIDE TYPE THERMOSTAT** MAKES THE SYSTEM OPERATE COLDER. IF THE THERMOSTAT IS SET TOO COLD THE EVAPORATOR COIL WILL "ICE UP"- MEANING, THE EVAPORATOR COIL IS RESTRICTED WITH ICE AND COLD AIR FLOW WILL BE REDUCED.
- TURNING THE KNOB TO THE LEFT (COUNTER CLOCKWISE) ON A **ROTARY TYPE THERMOSTAT** MAKES THE SYSTEM OPERATE WARMER. MOVING THE LEVER TOWARD S THE RED LINES ON A **SLIDE TYPE THERMOSTAT** MAKES THE SYSTEM OPERATE WARMER. THE COMPRESSOR CLUTCH WILL CYCLE OFF FREQUENTLY. THE EVAPORATOR COIL WILL NOT GET AS COLD AND THE AIR TEMPERATURE WILL NOT BE AS COLD.

## ADJUSTING A/C THERMOSTAT

- 1.) **SYMPTOM:** THE A/C WORKS WELL AT FIRST THEN QUILTS COOLING. THE AIR FLOW FROM THE VENTS IS LOW, AND THE COMPRESSOR CLUTCH CYCLES INFREQUENTLY.  
**SOLUTION:** THE THERMOSTAT IS SET TOO COLD AND THE EVAPORATOR IS "ICING UP" AND RESTRICTING AIR FLOW. **ALLOW THE ICE TO MELT** AND SET THE **ROTARY TYPE THERMOSTAT** WARMER (COUNTER CLOCKWISE) 1/8 OF A TURN EACH ADJUSTMENT UNTIL THE SYMPTOMS DIMINISH. ADJUST THE **SLIDE TYPE THERMOSTAT** IN 1/8" INCREMENTS TOWARDS THE SMALLER BLUE GRADIENTS, UNTIL THE SYMPTOMS DIMINISH.
- 2.) **SYMPTOM:** A/C NEVER GETS COLD AND THE COMPRESSOR CLUTCH CYCLES FREQUENTLY.  
**SOLUTION:** THE THERMOSTAT IS SET TOO WARM. SET THE **ROTARY TYPE THERMOSTAT** COLDER (CLOCKWISE) 1/8 OF A TURN EACH ADJUSTMENT, UNTIL THE DESIRED AIR TEMPERATURE IS REACHED. ADJUST **SLIDE TYPE THERMOSTAT** IN 1/8" INCREMENTS TOWARDS COLDER UNTIL THE DESIRED AIR TEMP IS REACHED **AVOID SETTING THE THERMOSTAT TOO COLD.**
- 3.) **SYMPTOM:** THE A/C NEVER GETS COLD, SOMETIMES EVEN BLOWS HOT, AND THE A/C COMPRESSOR CLUTCH INFREQUENTLY CYCLES OFF.  
**SOLUTION:** THE HEATER MAY BE ON AT ALL TIMES. **CAREFULLY** FEEL THE HEATER HOSE BETWEEN THE **EVAPORATOR** AND THE **HEATER CONTROL VALVE**. THIS HOSE SHOULD NOT BE HOT IN THE A/C MODE. IF THE HOSES ARE HOT ....
  - A)- THE HEATER CONTROL VALVE MAY BE INSTALLED BACKWARDS. CHECK THE FLOW DIRECTION ARROW ON THE VALVE AGAINST THE ILLUSTRATION IN YOUR INSTALLATION INSTRUCTIONS.
  - B)- IF CABLE OPERATED: THE VALVE MAY BE MISADJUSTED.
  - C)- IF VACUUM OPERATED: IT MAY BE GETTING VACUUM AT ALL TIMES (CHECK ELECTRIC SOLENOID).
  - D)- THE HEATER CONTROL VALVE MAY BE INSTALLED IN THE WRONG HOSE. IT MUST BE INSTALLED IN THE HOSE COMING FROM THE INTAKE MANIFOLD ENGINE COOLANT **PRESSURE PORT**.

**EVAPORATOR KIT  
11300-VUZ-A  
11400-VUZ-A**
**EVAPORATOR KIT PACKING LIST**

No.	QTY.	PART No.	DESCRIPTION
1.	1	55323-VUE-A	EVAPORATOR SUBCASE H/C/D w/ STD LOUVERS
		55423-VUE-A	EVAPORATOR SUBCASE H/C/D w/ BLK LOUVERS
2.	1	64143-VUE	FRONT EVAPORATOR BRKT. KIT
3.	1	63380-VUE	COMPAC DEFROST DUCTS
4.	1	63300-VUE	IK KIT
5.	6	06200-VUE	2" DEFROST DUCTS

 CHECKED BY: \_\_\_\_\_  
 PACKED BY: \_\_\_\_\_  
 DATE: \_\_\_\_\_
